



# Glamour CRAFTS

## How to make a Drawer Box

### Directions

Step 1: Cut 2 pieces of cardstock one at 9" x 12" and one at 9" x 9", the largest sheet will form the outside of the box and the small one the inside of the box.

Step 2: Take the largest piece and place it against the left side (Box lid) and score at 2" and 7", then rotate the cardstock and score at 5" and 7".

Step 3: Fold each of the score lines. Cut out a v-shaped notch according to the image below.

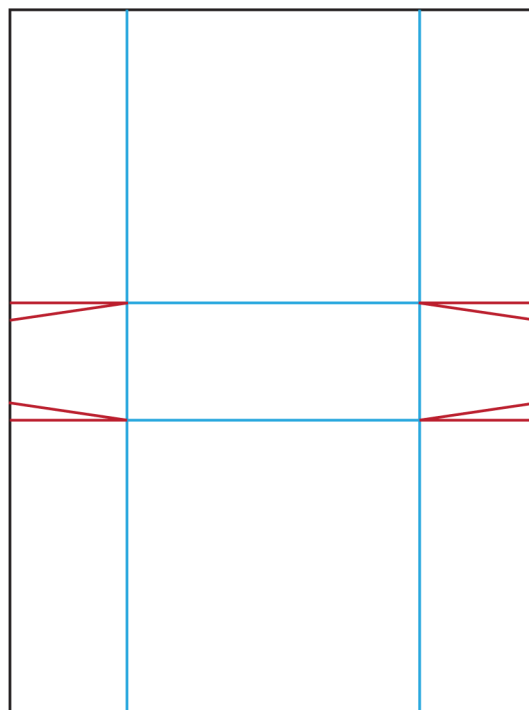
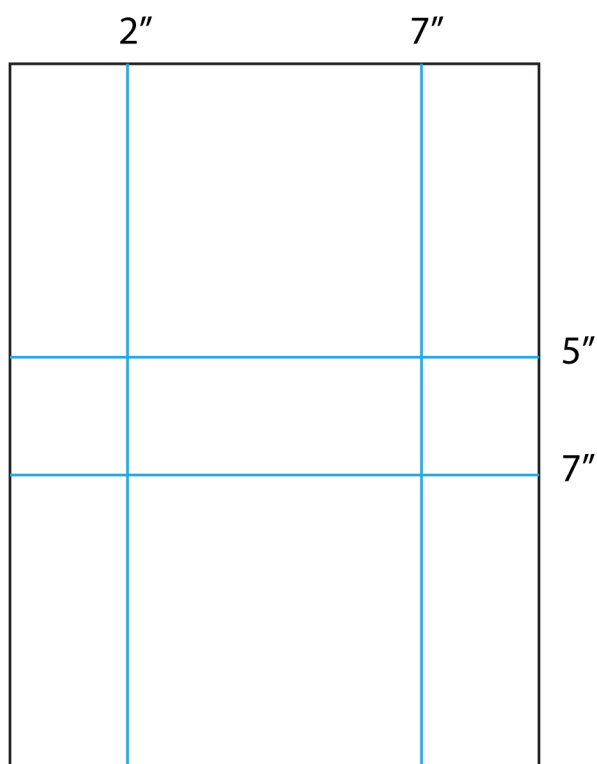

Step 4: Using adhesive on the inside face of the the two smallest flaps, adhere the flaps to the outside. Adhering the smallest flaps outside helps the inside box to slide better.

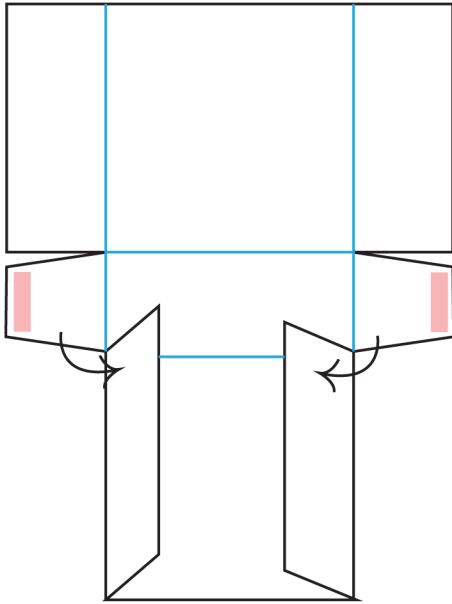

Step 5: Now add adhesive on the two largest flaps adhere the flaps to the outside of the box, see image below.

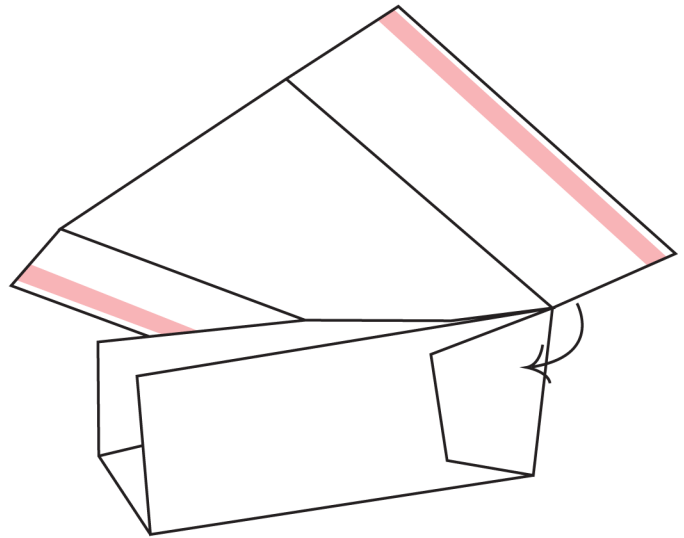

Step 6: Using the 9" x 9" paper, place it butted up against the right hand of the board (Box Base) and score at 2". Turn the cardstock and repeat the process scoring at 2" on all 4 sides, see image below.

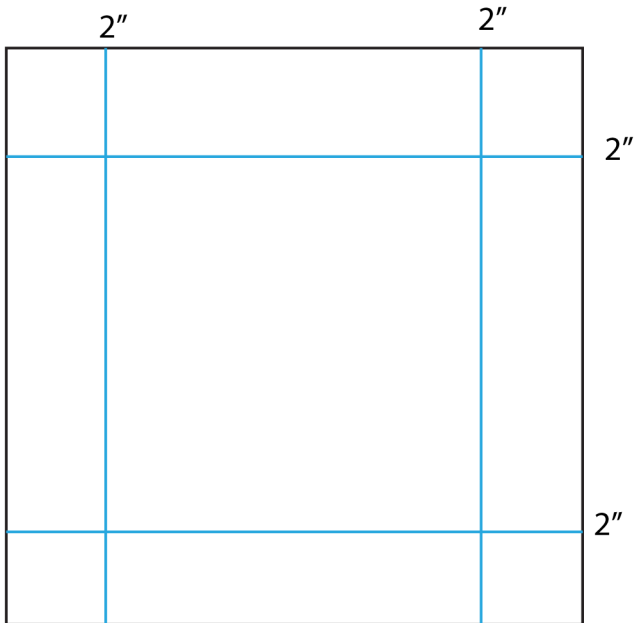

Step 7: In each of the corners where the scored lines intersect, cut a small v-shaped notch. The first cut should be along the score line and the diagonal line should be cut from the excess corner piece. See image below.

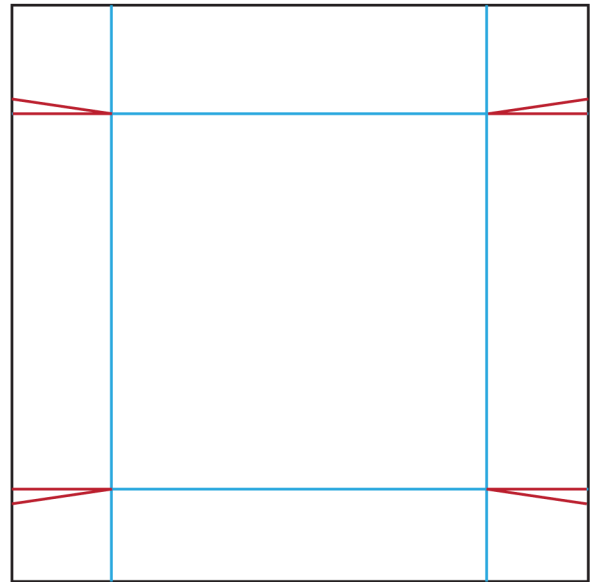

If you don't have The Ultimate Tool, score at 1 15/16" on each side.

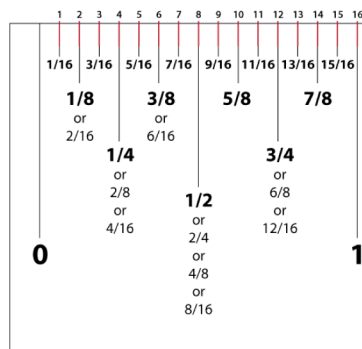

Ruler measurements

Step 8: Fold on the scores. Using adhesive, adhere the flaps to the inside of the box, see image below.

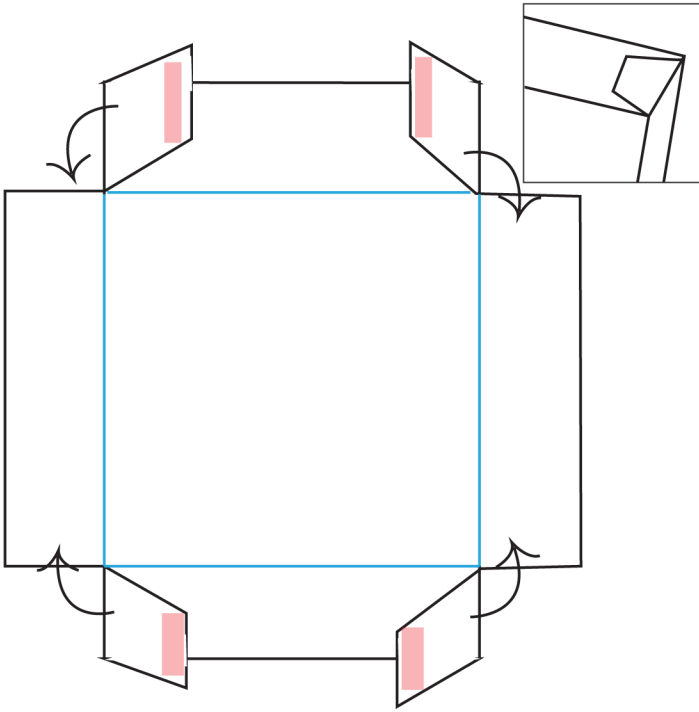

Step 9: The two pieces should now slide into place smoothly and your box is now ready to decorate.

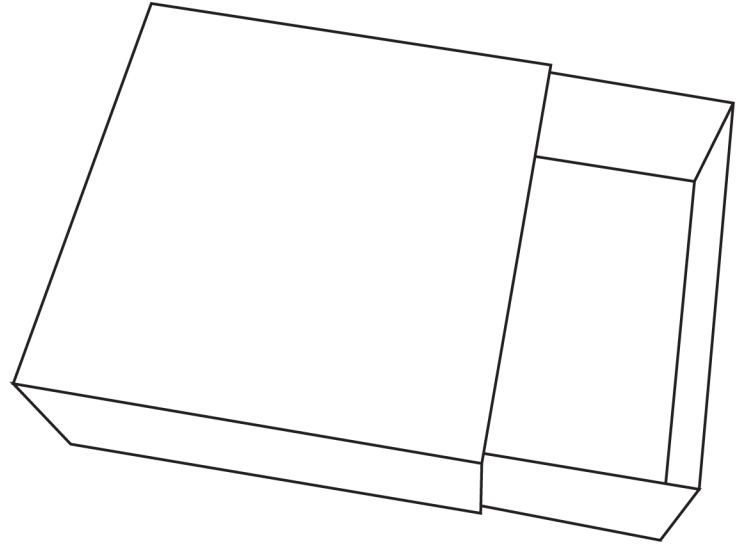

Step 10: To decorate the top of the box, you will need a piece of cardstock 4.75" x 6.75". Score at 4 7/8". Using the cutting machine, place you metal die where desired and cut. See image below.

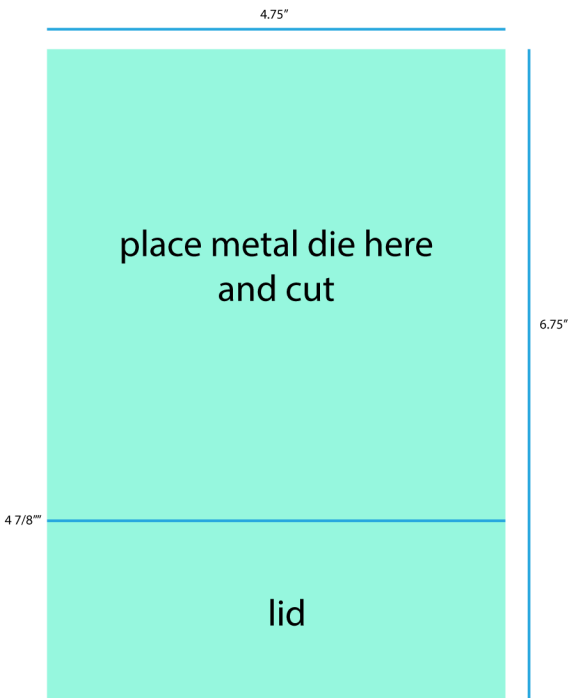

Step 11: Cut a piece of cardstock 4.75" x 4.75" and adhere on the back of the cutting design. Then adhere it to the top of the box, add velcro inside the flap to use it as a lid see images below.

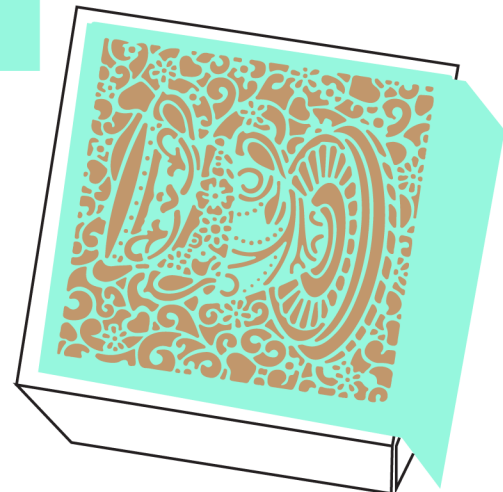
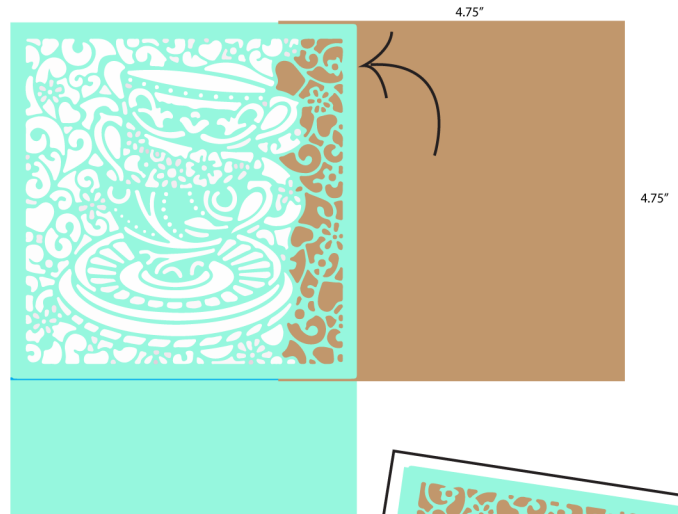



Step 12: Cut three pieces of cardstock at 4.5" x 1.5" and four pieces at 4.25" x 1.25" to decorate the sides of the box.

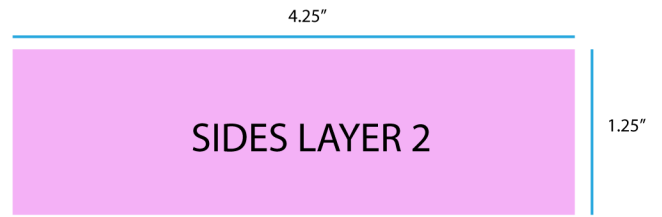
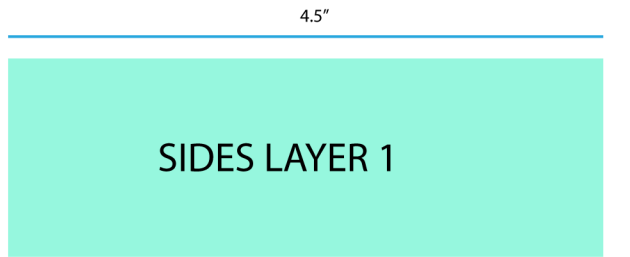

Decorate your box as you wish.



Finished project.

